

EZ36

Tracked Zero Tail Excavators



**WACKER
NEUSON**
all it takes!



Trimmed for productivity

The EZ36 is full of detailed solutions that increase productivity and make working for the operator even more enjoyable and efficient. The intuitive operating concept, combined with precise control, shortens working cycles and saves time and money. In addition, many options can be installed ex factory.

- Performance meets maximum efficiency
- User-friendly operating concept and comfort cabin
- VDS - Working in the slope - without coming to falter
- Zero Tail - when it gets tight
- Unrestricted maintenance and service access

EZ36 Technical specifications

Operating data

Shipping weight min.	3,530 kg
Operating weight	3,720 - 4,636 kg
Biting force max.	21.1 kN
Breakout force max.	35 kN
Digging depth max. (long dipperstick)	3,497 mm
Dumping height	3,336 - 3,336 mm
Digging radius max. (long dipperstick)	5,743 mm
Superstructure slewing speed	9.5 1/min
L x W x H	5,503 x 1,750 x 2,491 mm
Fuel tank capacity	44 l

Engine / Motor

Engine / Motor manufacturer	Yanmar Diesel engine
Engine / Motor type	3TNV88F
Engine / Motor	water-cooled 3-cylinder suction engine
Emission standards stage	5
Rated performance	18.2 kW
Displacement	1,642 cm ³
RPM / speed	2,400 rpm
Engine performance POWER Mode	18.2 kW

Battery

Battery	71 Ah
---------	-------

Hydraulic system

Duty pump	2 axial piston pumps / 2 gear pumps
Max. flow rate	42.5 + 42.5 l/min
Max. flow rate	23.8 + 11.3 l/min
Operating pressure for working and driving hydraulics	240 bar
Operating pressure Drehwerk	195 bar

Undercarriage

Travel speed max.	4.7 km/h
Chain width	300 mm
Ground clearance	251 mm

Dozer Blade

Width	1,750 mm
Height	357 mm
Stroke dozer blade above ground	393 mm
Stroke dozer blade below ground	505 mm

EZ36 Dimensions

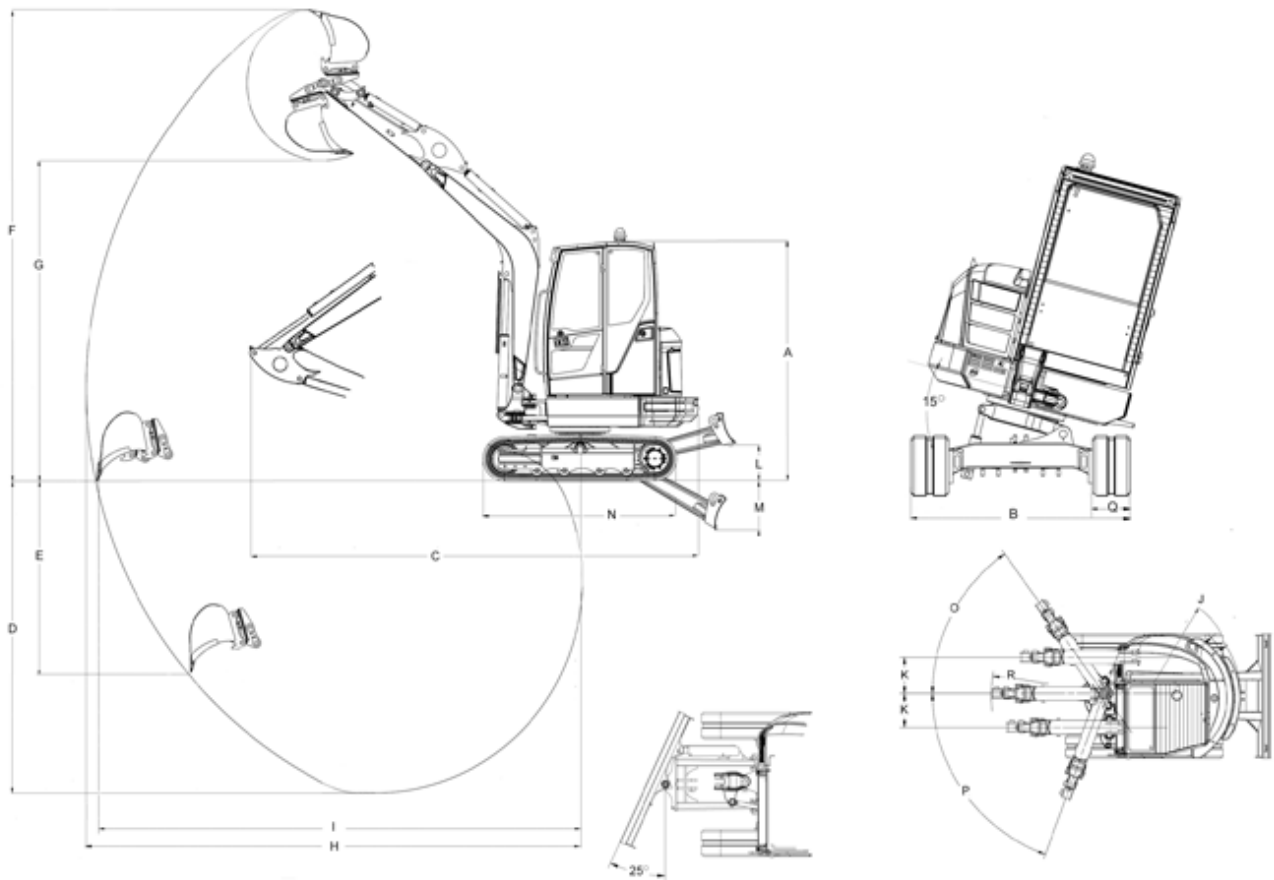

			VDS
A	Height	2,491 mm	2,573 mm
B	Width	1,750 mm	1,750 mm
C	Transport length	5,503 mm	5,489 mm
D	Digging depth max. (short dipperstick)	3,247 mm	3,172 mm
D	Digging depth max. (long dipperstick)	3,497 mm	3,422 mm
E	Insertion depth max. vertical (short dipperstick)	2,123 mm	2,048 mm
E	Insertion depth max. vertical (long dipperstick)	2,360 mm	2,285 mm
F	Insertion height max. (short dipperstick)	4,925 mm	5,004 mm
F	Insertion height max. (long dipperstick)	5,082 mm	5,157 mm
G	Dump height max. (short dipperstick)	3,336 mm	3,411 mm
G	Dump height max. (long dipperstick)	3,489 mm	3,564 mm
H	Digging radius max. (short dipperstick)	5,298 mm	5,270 mm
H	Digging radius max. (long dipperstick)	5,582 mm	5,546 mm
I	Range on the ground max. (short dipperstick)	5,391 mm	5,378 mm
I	Range on the ground max. (long dipperstick)	5,641 mm	5,629 mm
J	Rear swivel radius min.	933 mm	933 mm
K	Arm displacement max. to center bucket right side	680 mm	680 mm
K	Arm displacement max. to center bucket left side	650 mm	650 mm
L	Lift height max. dozer blade above ground	393 mm	393 mm

M	Scraping depth max. dozer blade below ground	505 mm	505 mm
N	Length undercarriage	2,062 mm	2,062 mm
O	Turning angle max. boom to the right	45 °	45 °
P	Turning angle max. boom to the left	70 °	70 °
--	Boom slewing radius center	2,245 mm	2,245 mm
Q	Width	300 mm	300 mm

Please note: that product availability can vary from country to country. It is possible that information / products may not be available in your country. More detailed information on engine power can be found in the operator's manual; the stated power may vary due to specific operating conditions. Subject to alterations and errors excepted. Applicable also to illustrations.
 Copyright © 2021 Wacker Neuson SE.